

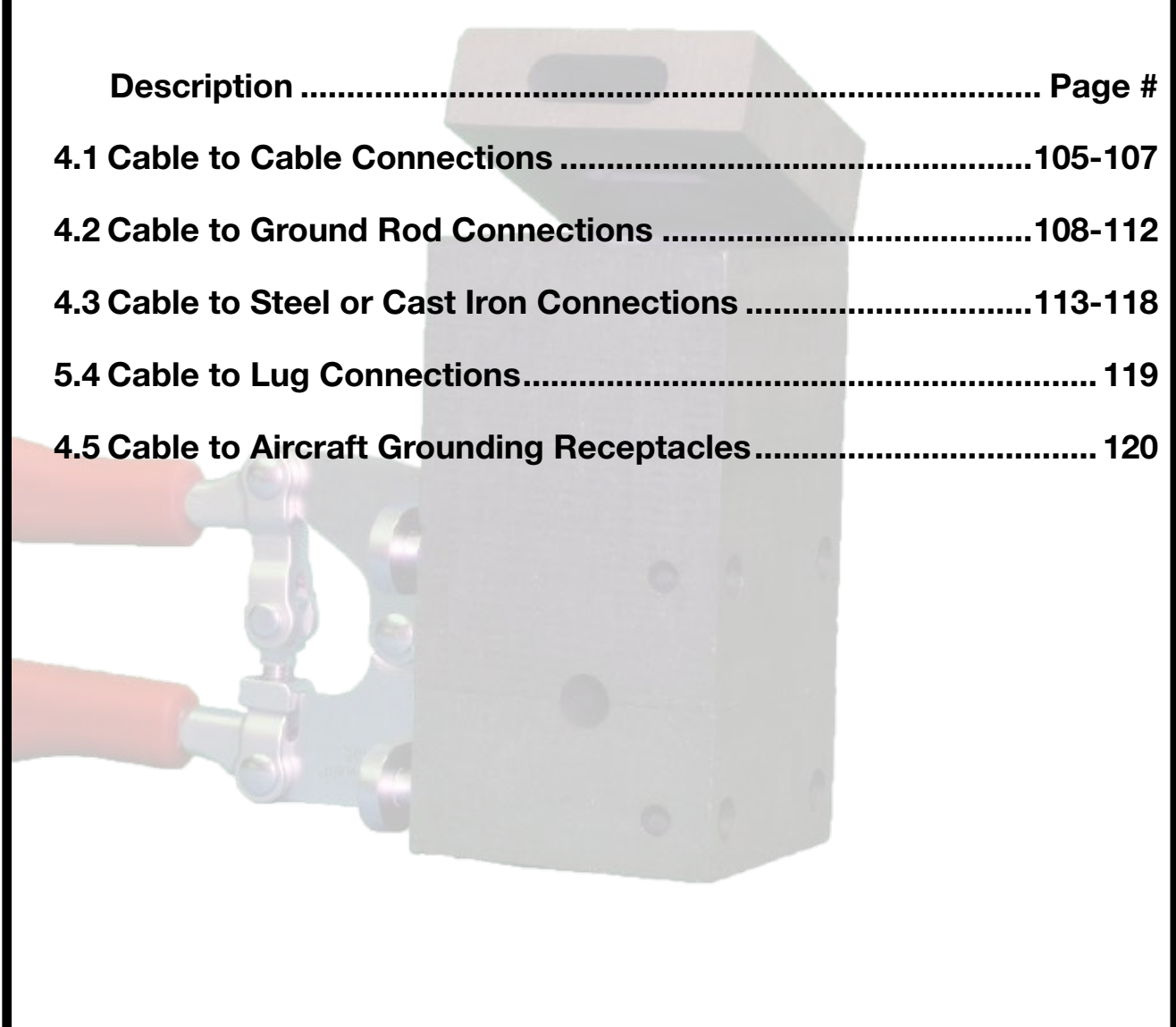





# Section 4





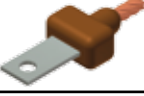



## Molds for use with Lightning Protection Conductors









Description .....	Page #
4.1 Cable to Cable Connections .....	105-107
4.2 Cable to Ground Rod Connections .....	108-112
4.3 Cable to Steel or Cast Iron Connections .....	113-118
5.4 Cable to Lug Connections.....	119
4.5 Cable to Aircraft Grounding Receptacles.....	120

Section 4 - Molds  
Lightning Protection Conductors

Weld Type		Page #
	AC-1	120
	AC-2	120
	CB-1	119
	CC-1	105
	CC-2	106
	CC-4	107
	CR-1	108

Weld Type		Page #
	CR-2	109
	CR-3	110
	CR-18	111
	CR-36	112
	CS-1	113
	CS-2	114
	CS-3	115
	CS-4	118

Weld Type		Page #
	CS-6	117
	CS-7	118
	CS-8	113
	CS-9	114
	CS-18	116
	CS-27	117
	Rebar Bond	163

See page 20 -29 for additional configurations.

Use the chart below to determine the cable code. Then select the weld connection type needed and then find the corresponding cable code to acquire the mold number, price key and cartridge size.

CABLE CODE	thermOweld	THOMPSON	ROBBINS	INDEPENDENT	AC	EAST COAST	HEARY	HARGER®	PREFERRED	ERICO®
A	36-7563-00, 36-7563-01	14	11A, 10	22	C-150	C14	HB6C	14	C61, C63	
B	36-7563-02, 36-7563-03	509	11		C-152		HB4C	10	C62	
C	36-7562-00, 36-7562-01, 36-7562-02, 36-7562-03, 36-7562-04, 36-7561-00, 36-7561-01	29X, 32	1	32S	C-122, C-122L	C29, C32	HB29-17C, HB32-17C	29, 30, 32, 33	C50, C50T, C51, C52, C52T, C53, C56-19	LPC120, LPC121, LPC122, LPC120L, LPC122L
D	36-7562-06, 36-7561-08, 36-7562-07, 36-7557-00, 36-7557-01	32S, 50S, 28R	601, 603	20, 500	C-125, C-126, C-128	C385	HB24-14C, HB28-14C	25, 35, 28	C54, C55, C58	LPC125, LPC126, LPC126L, LPC128
E			604	40, G1						
F	36-7557-02, 36-7557-03, 36-7561-02, 36-7561-03	36S, 506	602	36S	C-123, C-127		HB36-17C, BH28B-13C	20, 36	C56R	LPC123, LPC127
G				501,21, 44S, 40S	C-124		HB40-17C	40		LPC124
H				502						
J				501B						
K		507		G3				38		
L				502A						
Q	36-7561-04*, 36-7561-06*, 36-7561-07*		605*		C-137*	C4/0-19*	HB122-4/0*	54*, 64*	C59-19*, C59-37*	LPC137*

\* = 4/0 CONCENTRIC CABLE

Section 4 - Molds  
Lightning Protection Conductors

# CC-1

## TYPE MOLDS

*Horizontal End to End  
For Lightning Protection Conductors*

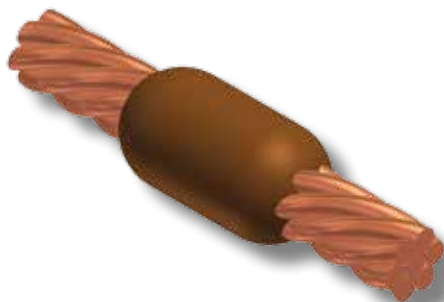

MOLDS FOR LIGHTNING PROTECTION CONDUCTORS					
Cable Code	Mold #	Price Key	Weld Metal	Handle Clamps	Lead Time
A	M-5002	4	25	B-106	4
B	M-5006	4	45	B-106	4
C	M-5032	4	65	B-106	2
D	M-5012	4	90	B-106	2
E	M-5013	4	90	B-106	2
F	M-5016	4	90	B-106	2
G	M-5005	4	115	B-106	2
H	M-2176	4	115	B-106	4
J	M-2178	4	115	B-106	4
K	M-2180	4	115	B-106	2
L	M-2182	4	150	B-106	4
Q	M-5077	4	90	B-106	SDS

- For sizes not listed, contact thermOweld®.
- For heavy duty connections, contact thermOweld®.
- For molds with wear plates, see page 135.
- For expedited service, contact thermOweld®.
- To order weld metal for use with EZ Lite Remote® insert TW before and EZ after weld metal number.
- Required Tools;
  - Handle Clamps w/ Flint Ignitor (see chart for correct handles)
  - 38-0309-00 ~ Flint Ignitor or 38-EZLT-RU EZ Lite Remote®
- Other recommended accessories;
  - 38-3922-00 ~ Mold Cleaning Brush
  - 38-0135-00 ~ Cable Cleaning Brush
  - 38-0330-00 ~ Cable Clamp

Section 4 - Molds  
Lightning Protection Conductors

## CC-2

### TYPE MOLDS

*Horizontal Cable Tap to Horizontal Cable Run  
For Lightning Protection Conductors*

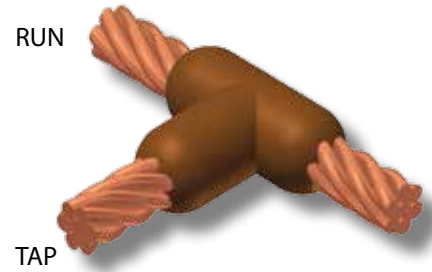

#### MOLDS FOR LIGHTNING PROTECTION CONDUCTORS

Cable Code		Mold #	Price Key	Weld Metal	Handle Clamps	Lead Time
Run	Tap					
A	A	M-5050	4	45	B-106	4
B	B	M-5056	4	65	B-106	2
	A	M-2183	4	45	B-106	4
C	C	M-5048	4	115	B-106	2
	B	M-2186	4	90	B-106	4
	A	M-2184	4	65	B-106	2
D	D	M-5287	4	115	B-106	2
	C	M-5040	4	90	B-106	2
	B	M-2185	4	90	B-106	4
	A	M-5288	4	65	B-106	2
E	E	M-5023	4	150	B-106	2
	D	M-5284	4	150	B-106	2
	C	M-2187	4	115	B-106	2
	B	M-2192	4	90	B-106	4
F	A	M-5286	4	90	B-106	4
	F	M-2193	4	150	B-106	2
	E	M-5014	4	150	B-106	2
	D	M-5015	4	115	B-106	2
	C	M-2194	4	115	B-106	2
	B	M-5019	4	90	B-106	2
G	A	M-5017	4	90	B-106	2
	Q	M-5018	4	150	B-106	4
	G	M-2195	4	150	B-106	2
	F	M-2197	4	150	B-106	4
	E	M-2222	4	150	B-106	4
	D	M-2223	4	115	B-106	4
	C	M-2224	4	115	B-106	4
	B	M-2225	4	90	B-106	4
H	A	M-2226	4	90	B-106	4
	Q	M-2227	4	150	B-106	4
	H	M-2228	4	150	B-106	4
	G	M-2229	4	150	B-106	4
	F	M-2230	4	150	B-106	4
	E	M-2231	4	150	B-106	4
	D	M-2232	4	115	B-106	4
	C	M-2233	4	115	B-106	4
J	B	M-2234	4	90	B-106	4
	A	M-2843	4	90	B-106	4
	Q	M-2236	4	150	B-106	4
	J	M-2237	4	200	B-106	4
	H	M-2238	4	150	B-106	4
	G	M-2239	4	150	B-106	4
	F	M-2240	4	150	B-106	4
	E	M-2241	4	150	B-106	4
K	D	M-2242	4	150	B-106	4
	C	M-2243	4	115	B-106	4
	B	M-2244	4	90	B-106	4
	A	M-2245	4	90	B-106	4
	Q	M-2246	4	150	B-106	4

#### MOLDS FOR LIGHTNING PROTECTION CONDUCTORS

Cable Code		Mold #	Price Key	Weld Metal	Handle Clamps	Lead Time
Run	Tap					
K	K	M-2247	4	200	B-106	2
	J	M-2248	4	200	B-106	4
	H	M-2249	4	200	B-106	4
	G	M-2250	4	150	B-106	2
	F	M-2251	4	150	B-106	4
	E	M-2252	4	150	B-106	2
	D	M-2253	4	150	B-106	2
	C	M-2254	4	150	B-106	2
	B	M-2255	4	115	B-106	4
	A	M-2256	4	115	B-106	4
	Q	M-2257	4	150	B-106	4
L	L	M-2258	4	250	B-106	4
	K	M-2259	4	200	B-106	4
	J	M-2260	4	200	B-106	4
	H	M-2261	4	200	B-106	4
	G	M-2262	4	200	B-106	4
	F	M-2263	4	200	B-106	4
	E	M-2264	4	150	B-106	2
	D	M-2265	4	150	B-106	4
	C	M-2266	4	150	B-106	4
	B	M-2267	4	115	B-106	4
	A	M-2268	4	115	B-106	4
Q	M-2269	4	200	B-106	4	
Q	Q	M-5283	4	150	B-106	2
	F	M-5033	4	150	B-106	2
	E	M-5035	4	150	B-106	2
	D	M-5036	4	115	B-106	2
	C	M-5020	4	115	B-106	2
	B	M-2270	4	90	B-106	2
	A	M-5037	4	90	B-106	2

- For sizes not listed, contact thermOweld®.
- For heavy duty connections, contact thermOweld®.
- For molds with wear plates, see page 135.
- For expedited service, contact thermOweld®.
- To order weld metal for use with EZ Lite Remote® insert TW before and EZ after weld metal number.
- Required Tools;
  - Handle Clamps w/ Flint Ignitor (see chart for correct handles)
  - 38-0309-00 ~ Flint Ignitor or 38-EZLT-RU EZ Lite Remote®
- Other recommended accessories;
  - 40-0319-01 ~ Mold Cleaner for cartridge sizes #15-#65
  - 40-0319-03 ~ Mold Cleaner for cartridge sizes #90-#500
  - 38-3922-00 ~ Mold Cleaning Brush
  - 38-0135-00 ~ Cable Cleaning Brush
  - 38-0330-00 ~ Cable Clamp

Section 4 - Molds  
Lightning Protection Conductors

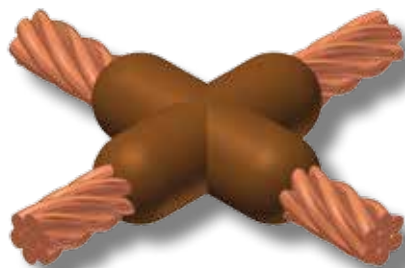

# CC-4

## TYPE MOLDS

*Horizontal to Horizontal Cable Cross  
For Lightning Protection Conductors  
Tap cable is cut*

MOLDS FOR LIGHTNING PROTECTION CONDUCTORS						
Cable Code		Mold #	Price Key	Weld Metal	Handle Clamps	Lead Time
Run	Tap					
A	A	M-2271	4	65	B-106	4
B	B	M-2272	4	90	B-106	4
	A	M-2273	4	65	B-106	4
C	C	M-2274	4	150	B-106	2
	B	M-2275	4	115	B-106	4
	A	M-2276	4	90	B-106	4
D	D	M-5231	4	150	B-106	2
	C	M-2277	4	150	B-106	2
	B	M-2278	4	115	B-106	4
	A	M-2279	4	90	B-106	4
E	E	M-2280	4	200	B-106	2
	D	M-2281	4	200	B-106	4
	C	M-2282	4	150	B-106	4
	B	M-2283	4	115	B-106	4
F	A	M-2284	4	115	B-106	4
	F	M-5232	4	200	B-106	2
	E	M-2285	4	200	B-106	4
	D	M-2286	4	150	B-106	4
	C	M-2287	4	150	B-106	4
	B	M-2288	4	115	B-106	4
	A	M-2289	4	115	B-106	4
Q	M-2290	4	200	B-106	4	
G	G	M-2291	4	200	B-106	2
	F	M-2292	4	200	B-106	4
	E	M-2293	4	200	B-106	4
	D	M-2294	4	150	B-106	4
	C	M-2295	4	150	B-106	4
	B	M-2296	4	115	B-106	4
	A	M-2297	4	115	B-106	4
	Q	M-2298	4	200	B-106	4
H	H	M-2299	4	200	B-106	4
	G	M-2300	4	200	B-106	4
	F	M-2301	4	200	B-106	4
	E	M-2302	4	200	B-106	4
	D	M-2303	4	150	B-106	4
	C	M-2304	4	150	B-106	4
	B	M-2305	4	115	B-106	4
	A	M-2306	4	115	B-106	4
Q	M-2307	4	200	B-106	4	
J	J	M-2308	4	250	B-106	2
	H	M-2309	4	200	B-106	4
	G	M-2310	4	200	B-106	4
	F	M-2311	4	200	B-106	4
	E	M-2312	4	200	B-106	4
	D	M-2313	4	200	B-106	4
	C	M-2314	4	150	B-106	4
	B	M-2315	4	115	B-106	4
	A	M-2316	4	115	B-106	4
	Q	M-2317	4	200	B-106	4

MOLDS FOR LIGHTNING PROTECTION CONDUCTORS							
Cable Code		Mold #	Price Key	Weld Metal	Handle Clamps	Lead Time	
Run	Tap						
K	K	M-2318	4	250	B-106	2	
	J	M-2319	4	250	B-106	4	
	H	M-2855	4	250	B-106	4	
	G	M-2321	4	200	B-106	4	
	F	M-2322	4	200	B-106	4	
	E	M-2323	4	200	B-106	4	
	D	M-2324	4	200	B-106	4	
	C	M-2325	4	200	B-106	4	
	B	M-2326	4	150	B-106	4	
	A	M-2327	4	150	B-106	4	
	Q	M-2328	4	200	B-106	4	
	L	L	M-2329	5	2-150	B-107	4
		K	M-2330	4	250	B-106	4
J		M-2331	4	250	B-106	4	
H		M-2332	4	250	B-106	4	
G		M-2333	4	250	B-106	4	
F		M-2334	4	250	B-106	4	
E		M-2335	4	200	B-106	4	
D		M-2336	4	200	B-106	4	
C		M-2337	4	200	B-106	4	
B		M-2338	4	150	B-106	4	
A	M-2339	4	150	B-106	4		
Q	M-2340	4	250	B-106	4		
Q	Q	M-5201	4	200	B-106	2	
	F	M-2341	4	200	B-106	4	
	E	M-2342	4	200	B-106	4	
	D	M-2343	4	150	B-106	2	
	C	M-2344	4	150	B-106	2	
	B	M-2345	4	115	B-106	4	
	A	M-2346	4	115	B-106	4	

- For sizes not listed, contact thermOweld®.
- For heavy duty connections, contact thermOweld®.
- For expedited service, contact thermOweld®.
- To order weld metal for use with EZ Lite Remote® insert TW before and EZ after weld metal number.
- Required Tools;
  - Handle Clamps w/ Flint Ignitor (see chart for correct handles)
    - 38-0309-00 ~ Flint Ignitor or 38-EZLT-RU EZ Lite Remote®
- Other recommended accessories;
  - 40-0319-01 ~ Mold Cleaner for cartridge sizes #15-#65
  - 40-0319-03 ~ Mold Cleaner for cartridge sizes #90-#500
  - 38-3922-00 ~ Mold Cleaning Brush
  - 38-0135-00 ~ Cable Cleaning Brush
  - 38-0330-00 ~ Cable Clamp

Section 4 - Molds  
Lightning Protection Conductors

## CR-1

### TYPE MOLDS

*Horizontal Cable Terminal to Ground Rod  
For Lightning Protection Conductors*

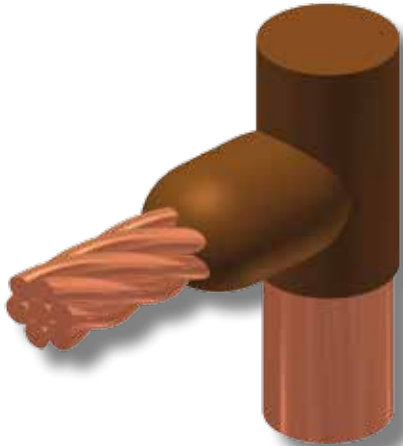

#### NOTES

- Molds listed are for copper clad steel ground rods: 1/2" rods are 0.475" diameter, 5/8" rods are 0.563" diameter, 3/4" rods are 0.682" diameter, and 1" rods are 0.914" diameter. Undersized ground rods may require shim stock or packing material.
- Molds are available for galvanized steel, stainless steel, and solid copper rods that are sold by actual diameter. The suffix "-N" is added to the mold number, i.e. M-XXX-N is for full sized rods.
- Molds are available for sectional/threaded copper clad steel ground rods. The suffix "-T" is added to the mold number, i.e. M-XXX-T is for a sectional/threaded ground rod.

- **For sizes not listed, contact thermOweld®.**
- Molds listed are for copper clad ground rods. For welding to steel, stainless steel or galvanized steel ground rods add suffix "-N" to mold number.
- For heavy duty connections, contact thermOweld®.
- For molds with wear plates, see page 135.
- For expedited service, contact thermOweld®.
- To order weld metal for use with EZ Lite Remote® insert TW before and EZ after weld metal number.
- Required Tools;
  - Handle Clamps w/ Flint Ignitor (see chart for correct handles) 38-0309-00 ~ Flint Ignitor or 38-EZLT-RU EZ Lite Remote®
- Other recommended accessories;
  - 38-3922-00 ~ Mold Cleaning Brush
  - 38-0135-00 ~ Cable Cleaning Brush
  - 38-0304-00 ~ File
  - 38-0330-00 ~ Cable Clamp

MOLDS FOR LIGHTNING PROTECTION CONDUCTORS						
Ground Rod Size	Cable Code	Mold #	Price Key	Weld Metal	Handle Clamps	Lead Time
1/2"	A	M-5060	4	90	B-106	2
	B	M-2347	4	90	B-106	4
	C	M-5064	4	90	B-106	4
	D	M-5061	4	115	B-106	2
	E	M-5062	4	115	B-106	2
	F	M-5063	4	115	B-106	4
	G	M-2348	4	115	B-106	4
	H	M-2349	4	115	B-106	4
	J	M-2350	4	115	B-106	4
	K	M-2351	4	115	B-106	4
	L	M-2352	4	150	B-106	4
Q	M-5022	4	90	B-106	4	
5/8"	A	M-5066	4	90	B-106	2
	B	M-2353	4	90	B-106	4
	C	M-5073	4	115	B-106	2
	D	M-5069	4	115	B-106	2
	E	M-5070	4	115	B-106	2
	F	M-5071	4	115	B-106	2
	G	M-2354	4	115	B-106	2
	H	M-2355	4	115	B-106	4
	J	M-2356	4	115	B-106	4
	K	M-2357	4	115	B-106	2
	L	M-2358	4	150	B-106	4
Q	M-5038	4	90	B-106	4	
3/4"	A	M-5079	4	90	B-106	2
	B	M-5086	4	90	B-106	4
	C	M-5085	4	115	B-106	2
	D	M-5081	4	115	B-106	2
	E	M-5083	4	115	B-106	2
	F	M-5084	4	115	B-106	2
	G	M-2359	4	115	B-106	2
	H	M-2360	4	115	B-106	4
	J	M-2361	4	115	B-106	2
	K	M-2362	4	115	B-106	2
	L	M-2363	4	150	B-106	4
Q	M-5039	4	90	B-106	4	
1"	A	M-2364	4	150	B-106	4
	B	M-2365	4	150	B-106	4
	C	M-2366	4	150	B-106	4
	D	M-2367	4	150	B-106	2
	E	M-5089	4	150	B-106	4
	F	M-2368	4	200	B-106	4
	G	M-2369	4	200	B-106	4
	H	M-2370	4	200	B-106	4
	J	M-2371	4	200	B-106	4
	K	M-2372	4	200	B-106	4
	L	M-2373	4	250	B-106	4
Q	M-5041	4	150	B-106	4	

# CR-2

## TYPE MOLDS

Horizontal Cable to Ground Rod  
For Lightning Protection Conductors

MOLDS FOR LIGHTNING PROTECTION CONDUCTORS						
Ground Rod Size	Cable Code	Mold #	Price Key	Weld Metal	Handle Clamps	Lead Time
1/2"	A	M-5090	4	90	B-106	4
	B	M-2374	4	90	B-106	4
	C	M-2375	4	115	B-106	2
	D	M-5091	4	115	B-106	2
	E	M-5092	4	115	B-106	4
	F	M-5093	4	115	B-106	4
	G	M-2376	4	150	B-106	4
	H	M-2377	4	150	B-106	4
	J	M-2378	4	150	B-106	4
	K	M-2379	4	150	B-106	4
	L	M-2380	4	200	B-106	4
Q	M-5088	4	115	B-106	4	
5/8"	A	M-5094	4	90	B-106	4
	B	M-2381	4	115	B-106	4
	C	M-5099	4	150	B-106	2
	D	M-5095	4	150	B-106	2
	E	M-5097	4	150	B-106	2
	F	M-5098	4	150	B-106	2
	G	M-2382	4	200	B-106	2
	H	M-2383	4	200	B-106	4
	J	M-2384	4	200	B-106	4
	K	M-2385	4	200	B-106	2
	L	M-2386	4	250	B-106	4
Q	M-5051	4	115	B-106	2	
3/4"	A	M-5100	4	90	B-106	4
	B	M-5106	4	115	B-106	2
	C	M-5105	4	150	B-106	2
	D	M-5102	4	150	B-106	2
	E	M-5103	4	150	B-106	2
	F	M-5104	4	150	B-106	2
	G	M-2387	4	200	B-106	2
	H	M-2388	4	200	B-106	4
	J	M-2389	4	200	B-106	4
	K	M-2390	4	200	B-106	2
	L	M-2391	4	250	B-106	4
Q	M-5052	4	115	B-106	4	
1"	A	M-2392	4	150	B-106	4
	B	M-2393	4	150	B-106	4
	C	M-2394	4	150	B-106	4
	D	M-2395	4	200	B-106	4
	E	M-2396	4	200	B-106	4
	F	M-2397	4	250	B-106	4
	G	M-2398	4	250	B-106	4
	H	M-2399	4	250	B-106	4
	J	M-2400	4	250	B-106	4
	K	M-2401	4	250	B-106	4
	L	M-2402	4	2-150	B-106	4
Q	M-5055	4	150	B-106	4	

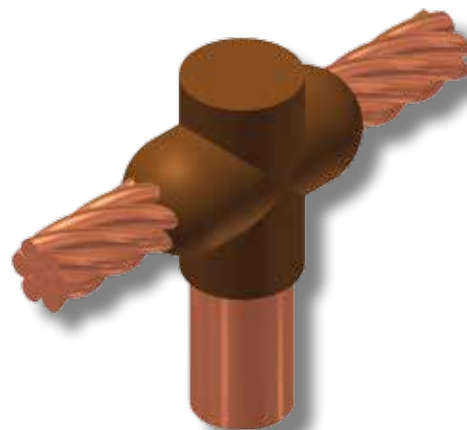

NOTES

1. Molds listed are for copper clad steel ground rods: 1/2" rods are 0.475" diameter, 5/8" rods are 0.563" diameter, 3/4" rods are 0.682" diameter, and 1" rods are 0.914" diameter. **Undersized ground rods may require shim stock or packing material.**
2. Molds are available for galvanized steel, stainless steel, and solid copper rods that are sold by actual diameter. The suffix "-N" is added to the mold number, i.e. M-XXX-N is for full sized rods.
3. Molds are available for sectional/threaded copper clad steel ground rods. The suffix "-T" is added to the mold number, i.e. M-XXX-T is for a sectional/threaded ground rod.

- For sizes not listed, contact thermOweld®.
- Molds listed are for copper clad ground rods. For welding to steel, stainless steel or galvanized steel ground rods add suffix "-N" to mold number.
- For heavy duty connections, contact thermOweld®.
- For molds with wear plates, see page 135.
- For expedited service, contact thermOweld®.
- To order weld metal for use with EZ Lite Remote® insert TW before and EZ after weld metal number.
- Required Tools;
  - Handle Clamps w/ Flint Ignitor (see chart for correct handles)
    - 38-0309-00 ~ Flint Ignitor or 38-EZLT-RU EZ Lite Remote®
- Other recommended accessories;
  - 38-3922-00 ~ Mold Cleaning Brush
  - 38-0135-00 ~ Cable Cleaning Brush
  - 38-0304-00 ~ File
  - 38-0330-00 ~ Cable Clamp

## CR-3

### TYPE MOLDS

**Horizontal Thru Cable to Ground Rod  
For Lightning Protection Conductors**

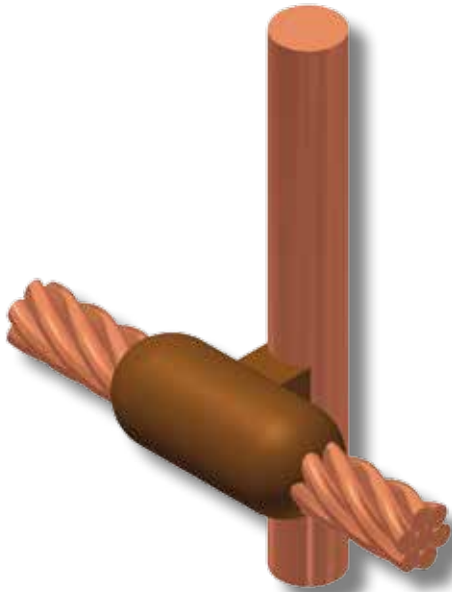

MOLDS FOR LIGHTNING PROTECTION CONDUCTORS						
Ground Rod Size	Cable Code	Mold #	Price Key	Weld Metal	Handle Clamps	Lead Time
1/2"	A	M-5107	24	90	B-106	4
	B	M-2403	24	115	B-106	4
	C	M-5111	24	150	B-106	2
	D	M-5108	24	150	B-106	4
	E	M-5109	24	150	B-106	4
	F	M-5110	24	150	B-106	4
	G	M-2404	24	200	B-106	4
	H	M-2405	24	200	B-106	4
	J	M-2406	24	200	B-106	4
	K	M-2407	24	200	B-106	4
5/8"	L	M-2408	24	250	B-106	4
	Q	M-5057	24	150	B-106	4
	A	M-5114	24	90	B-106	4
	B	M-2409	24	115	B-106	4
	C	M-5118	24	150	B-106	2
	D	M-5115	24	150	B-106	2
	E	M-5116	24	150	B-106	2
	F	M-5117	24	150	B-106	2
	G	M-2410	24	200	B-106	4
	H	M-2411	24	200	B-106	4
3/4"	J	M-2412	24	200	B-106	4
	K	M-2413	24	200	B-106	2
	L	M-2414	24	250	B-106	4
	Q	M-5058	24	150	B-106	4
	A	M-5119	24	90	B-106	2
	B	M-5125	24	115	B-106	4
	C	M-5124	24	150	B-106	2
	D	M-5120	24	150	B-106	2
	E	M-5121	24	150	B-106	2
	F	M-5123	24	150	B-106	2
1"	G	M-2415	24	200	B-106	2
	H	M-2416	24	200	B-106	4
	J	M-2417	24	200	B-106	4
	K	M-2418	24	200	B-106	2
	L	M-2419	24	250	B-106	4
	Q	M-2420	24	150	B-106	2
	A	M-2421	24	90	B-106	4
	B	M-2422	24	115	B-106	4
	C	M-2423	24	150	B-106	4
	D	M-2424	24	150	B-106	4
E	M-2174	24	150	B-106	4	
1"	F	M-2425	24	150	B-106	2
	G	M-2426	24	200	B-106	2
	H	M-5122	24	200	B-106	4
	J	M-5132	24	200	B-106	2
	K	M-2427	24	200	B-106	4
	L	M-2428	24	250	B-106	4
	Q	M-2429	24	150	B-106	2

#### NOTES

- Molds listed are for copper clad steel ground rods: 1/2" rods are 0.475" diameter, 5/8" rods are 0.563" diameter, 3/4" rods are 0.682" diameter, and 1" rods are 0.914" diameter. **Undersized ground rods may require shim stock or packing material.**
- Molds are available for galvanized steel, stainless steel, and solid copper rods that are sold by actual diameter. The suffix "-N" is added to the mold number, i.e. M-XXX-N is for full sized rods.
- Molds are available for sectional/threaded copper clad steel ground rods. The suffix "-T" is added to the mold number, i.e. M-XXX-T is for a sectional/threaded ground rod.

- **For sizes not listed, contact thermOweld®.**
- Molds listed are for copper clad ground rods. For welding to steel, stainless steel or galvanized steel ground rods add suffix "-N" to mold number.
- For heavy duty connections, contact thermOweld®.
- For molds with wear plates, see page 135.
- For expedited service, contact thermOweld®.
- To order weld metal for use with EZ Lite Remote® insert TW before and EZ after weld metal number.
- Required Tools;
  - Handle Clamps w/ Flint Ignitor (see chart for correct handles)
  - 38-0309-00 ~ Flint Ignitor or 38-EZLT-RU EZ Lite Remote®
- Other recommended accessories;
  - 38-3922-00 ~ Mold Cleaning Brush
  - 38-0135-00 ~ Cable Cleaning Brush
  - 38-0304-00 ~ File
  - 38-0330-00 ~ Cable Clamp



# CR-18

## TYPE MOLDS

Vertical Cable Up to Ground Rod  
For Lightning Protection Conductors



MOLDS FOR LIGHTNING PROTECTION CONDUCTORS						
Ground Rod Size	Cable Code	Mold #	Price Key	Weld Metal	Handle Clamps	Lead Time
1/2"	A	M-10570	17	90	B-106	4
	B	M-10571	17	90	B-106	4
	C	M-10572	17	115	B-106	4
	D	M-10573	17	150	B-106	4
	E	M-10574	17	150	B-106	4
	F	M-10575	17	150	B-106	4
	G	M-10576	17	150	B-106	4
	H	M-10577	17	150	B-106	4
	J	M-10578	17	200	B-106	4
	K	M-10579	17	200	B-106	4
L	M-10580	17	250	B-106	4	
Q	M-10581	17	150	B-106	4	
5/8"	A	M-10582	17	90	B-106	4
	B	M-10583	17	90	B-106	4
	C	M-5177	17	150	B-106	2
	D	M-8472	17	150	B-106	2
	E	M-10584	17	150	B-106	4
	F	M-10585	17	150	B-106	4
	G	M-10586	17	150	B-106	4
	H	M-10587	17	150	B-106	4
	J	M-10588	17	200	B-106	4
	K	M-10589	17	200	B-106	4
L	M-10590	17	250	B-106	4	
Q	M-10591	17	150	B-106	4	
3/4"	A	M-10592	17	115	B-106	4
	B	M-10593	17	115	B-106	4
	C	M-8177	17	150	B-106	2
	D	M-10594	17	200	B-106	4
	E	M-5490	17	200	B-106	4
	F	M-10595	17	200	B-106	4
	G	M-10596	17	200	B-106	4
	H	M-10597	17	200	B-106	4
	J	M-10598	17	200	B-106	4
	K	M-2138	17	200	B-106	4
L	M-10599	17	250	B-106	4	
Q	M-10600	17	150	B-106	4	
1"	A	M-10601	17	150	B-106	4
	B	M-10602	17	150	B-106	4
	C	M-10603	17	200	B-106	4
	D	M-10604	17	200	B-106	4
	E	M-10605	17	200	B-106	4
	F	M-10606	17	250	B-106	4
	G	M-10607	17	250	B-106	4
	H	M-10608	17	250	B-106	4
	J	M-10609	17	250	B-106	4
	K	M-10610	17	250	B-106	4
L	M-10611	17	2-150	B-106	4	
Q	M-10612	17	200	B-106	4	

NOTES

- Molds listed are for copper clad steel ground rods: 1/2" rods are 0.475" diameter, 5/8" rods are 0.563" diameter, 3/4" rods are 0.682" diameter, and 1" rods are 0.914" diameter. **Undersized ground rods may require shim stock or packing material.**
- Molds are available for galvanized steel, stainless steel, and solid copper rods that are sold by actual diameter. The suffix "-N" is added to the mold number, i.e. M-XXX-N is for full sized rods.
- Molds are available for sectional/threaded copper clad steel ground rods. The suffix "-T" is added to the mold number, i.e. M-XXX-T is for a sectional/threaded ground rod.

- For sizes not listed, contact thermOweld®.**
- Molds listed are for copper clad ground rods. For welding to steel, stainless steel or galvanized steel ground rods add suffix "-N" to mold number.
- For heavy duty connections, contact thermOweld®.
- For molds with wear plates, see page 135.
- For expedited service, contact thermOweld®.
- To order weld metal for use with EZ Lite Remote® insert TW before and EZ after weld metal number.
- Required Tools;
  - Handle Clamps w/ Flint Ignitor (see chart for correct handles) 38-0309-00 ~ Flint Ignitor or 38-EZLT-RU EZ Lite Remote®
- Other recommended accessories;
  - 38-3922-00 ~ Mold Cleaning Brush
  - 38-0135-00 ~ Cable Cleaning Brush
  - 38-0304-00 ~ File
  - 38-0330-00 ~ Cable Clamp

Section 4 - Molds  
Lightning Protection Conductors

## CR-36

### TYPE MOLDS

30° Up Cable to Ground Rod

For Lightning Protection Conductors

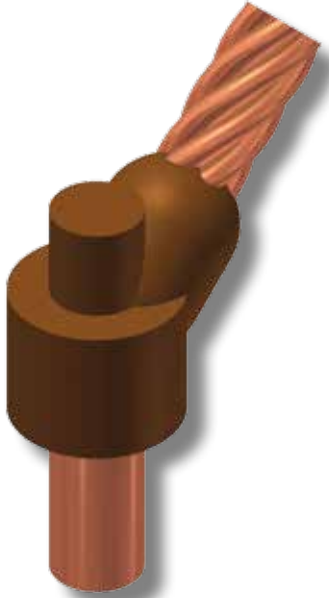

#### NOTES

1. Molds listed are for copper clad steel ground rods: 1/2" rods are 0.475" diameter, 5/8" rods are 0.563" diameter, 3/4" rods are 0.682" diameter, and 1" rods are 0.914" diameter. **Undersized ground rods may require shim stock or packing material.**
2. Molds are available for galvanized steel, stainless steel, and solid copper rods that are sold by actual diameter. The suffix "-N" is added to the mold number, i.e. M-XXX-N is for full sized rods.
3. Molds are available for sectional/threaded copper clad steel ground rods. The suffix "-T" is added to the mold number, i.e. M-XXX-T is for a sectional/threaded ground rod.

- For sizes not listed, contact thermOweld®.
- Molds listed are for copper clad ground rods. For welding to steel, stainless steel or galvanized steel ground rods add suffix "-N" to mold number.
- For heavy duty connections, contact thermOweld®.
- For molds with wear plates, see page 135.
- For expedited service, contact thermOweld®.
- To order weld metal for use with EZ Lite Remote® insert TW before and EZ after weld metal number.
- Required Tools;
  - Handle Clamps w/ Flint Ignitor (see chart for correct handles) 38-0309-00 ~ Flint Ignitor or 38-EZLT-RU EZ Lite Remote®
- Other recommended accessories;
  - 38-3922-00 ~ Mold Cleaning Brush
  - 38-0135-00 ~ Cable Cleaning Brush
  - 38-0304-00 ~ File
  - 38-0330-00 ~ Cable Clamp

#### MOLDS FOR LIGHTNING PROTECTION CONDUCTORS

Ground Rod Size	Cable Code	Mold #	Price Key	Weld Metal	Handle Clamps	Lead Time
1/2"	A	M-10613	17	90	B-106	4
	B	M-10614	17	90	B-106	4
	C	M-10615	17	115	B-106	4
	D	M-10616	17	150	B-106	4
	E	M-10617	17	150	B-106	4
	F	M-10618	17	150	B-106	4
	G	M-10619	17	150	B-106	4
	H	M-10620	17	150	B-106	4
	J	M-10621	17	200	B-106	4
	K	M-10622	17	200	B-106	4
	L	M-10623	17	250	B-106	4
Q	M-10624	17	150	B-106	4	
5/8"	A	M-10625	17	90	B-106	4
	B	M-10626	17	90	B-106	4
	C	M-10627	17	115	B-106	4
	D	M-10628	17	150	B-106	4
	E	M-10629	17	150	B-106	2
	F	M-10630	17	150	B-106	4
	G	M-10631	17	150	B-106	4
	H	M-10632	17	150	B-106	4
	J	M-10633	17	200	B-106	4
	K	M-10634	17	200	B-106	4
	L	M-10635	17	250	B-106	4
Q	M-10636	17	150	B-106	4	
3/4"	A	M-10637	17	115	B-106	4
	B	M-10638	17	115	B-106	4
	C	M-10639	17	150	B-106	4
	D	M-10640	17	200	B-106	4
	E	M-10641	17	200	B-106	4
	F	M-10642	17	200	B-106	4
	G	M-10643	17	200	B-106	4
	H	M-10644	17	200	B-106	4
	J	M-10645	17	200	B-106	4
	K	M-10646	17	200	B-106	4
	L	M-10647	17	250	B-106	4
Q	M-10648	17	150	B-106	4	
1"	A	M-10649	17	150	B-106	4
	B	M-10650	17	150	B-106	4
	C	M-10651	17	200	B-106	4
	D	M-10652	17	200	B-106	4
	E	M-10653	17	250	B-106	4
	F	M-10654	17	250	B-106	4
	G	M-10655	17	250	B-106	4
	H	M-10656	17	250	B-106	4
	J	M-10657	17	250	B-106	4
	K	M-10658	17	250	B-106	4
	L	M-10659	17	2-150	B-106	4
Q	M-10660	17	200	B-106	4	

# CS-1

## TYPE MOLDS

**Horizontal Cable to Horizontal Steel Surface  
For Lightning Protection Conductors**

Note that the cable is OFF the surface

MOLDS FOR LIGHTNING PROTECTION CONDUCTORS					
Cable Code	Mold #	Price Key	Weld Metal	Handle Clamps	Lead Time
D	M-5134	4	115	B-106	2
E	M-5135	4	115	B-106	4
F	M-5136	4	115	B-106	4
G	M-2430	4	115	B-106	2
H	M-2431	4	115	B-106	4
J	M-2432	4	150	B-106	4
K	M-2433	4	200	B-106	4
L	M-2434	4	250	B-106	4
Q	M-5290	4	115	B-106	2

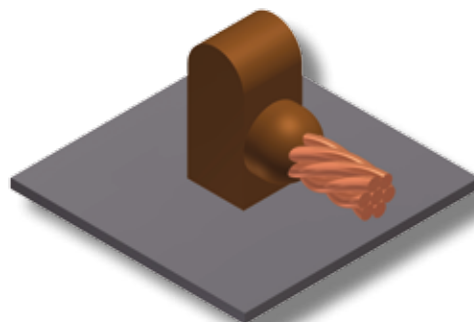

# CS-8

## TYPE MOLDS

**Horizontal Cable to Horizontal Steel Surface  
For Lightning Protection Conductors**

Note that the cable is ON the surface

MOLDS FOR LIGHTNING PROTECTION CONDUCTORS					
Cable Code	Mold #	Price Key	Weld Metal	Handle Clamps	Lead Time
A	M-5127	3†	45	Included	4
B	M-2455	3†	65	Included	2
C	M-5133	4	90	B-106	2
D	M-5128	4	115	B-106	2
E	M-5129	4	115	B-106	4
F	M-5131	4	115	B-106	2
G	M-2456	4	115	B-106	4
H	M-2457	4	115	B-106	4
J	M-2458	4	150	B-106	4
K	M-2459	4	200	B-106	4
L	M-2460	4	250	B-106	4
Q	M-5126	4	115	B-106	2

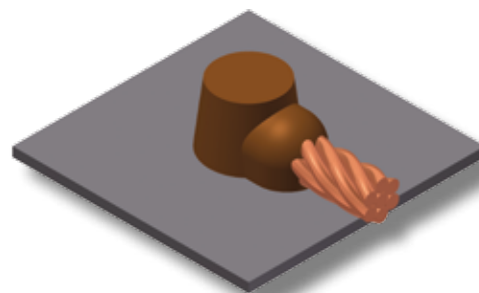

- For sizes not listed, contact thermOweld®.
- For heavy duty connections, contact thermOweld®.
- For molds with wear plates, see page 135.
- For expedited service, contact thermOweld®.
- To order weld metal for use with EZ Lite Remote® insert TW before and EZ after weld metal number.
- Required Tools;
  - Handle Clamps w/ Flint Ignitor (see chart for correct handles)
  - † ~ Sold complete with frame
  - 38-0309-00 ~ Flint Ignitor or 38-EZLT-RU EZ Lite Remote®
- Other recommended accessories;
  - 40-0319-01 ~ Mold Cleaner for cartridge sizes #15-#65 (Price Key 3, CS-8 Molds Only)
  - 38-3922-00 ~ Mold Cleaning Brush
  - 38-0135-00 ~ Cable Cleaning Brush
  - 38-0101-00 ~ Rasp
  - 38-4129-00 ~ Packing Material for cable code "C" & Larger Molds (CS-8 Molds Only)

## CS-2

### TYPE MOLDS

*Horizontal Thru Cable to Horizontal Steel Surface  
For Lightning Protection Conductors*

Note that the cable is OFF the surface

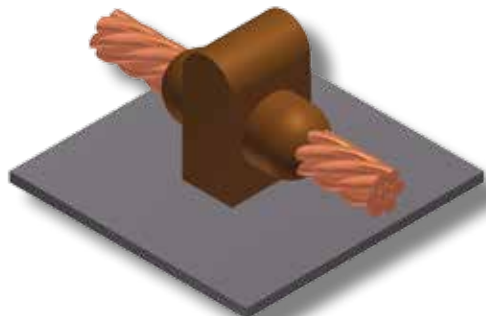

MOLDS FOR LIGHTNING PROTECTION CONDUCTORS					
Cable Code	Mold #	Price Key	Weld Metal	Handle Clamps	Lead Time
D	M-5141	4	150	B-106	2
E	M-5142	4	150	B-106	4
F	M-5143	4	150	B-106	2
G	M-2435	4	150	B-106	4
H	M-2436	4	150	B-106	4
J	M-2437	4	200	B-106	4
K	M-2438	4	200	B-106	4
L	M-2439	4	250	B-106	4
Q	M-5137	4	150	B-106	2

## CS-9

### TYPE MOLDS

*Horizontal Thru Cable to Horizontal Steel Surface  
For Lightning Protection Conductors*

Note that the cable is ON the surface

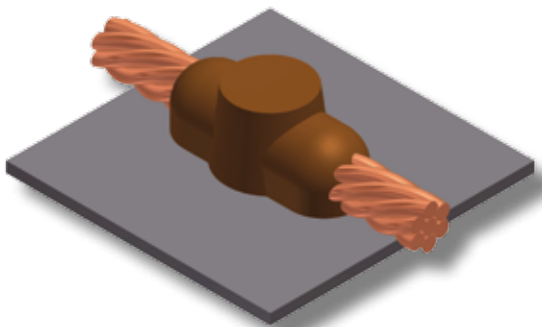

MOLDS FOR LIGHTNING PROTECTION CONDUCTORS					
Cable Code	Mold #	Price Key	Weld Metal	Handle Clamps	Lead Time
A	M-10661	3†	65	Included	4
B	M-10662	3†	65	Included	4
C	M-10663	4	90	B-106	4
D	M-10664	4	150	B-106	4
E	M-10665	4	150	B-106	4
F	M-10666	4	150	B-106	4
G	M-10667	4	150	B-106	4
H	M-10668	4	150	B-106	4
J	M-10669	4	200	B-106	4
K	M-10670	4	200	B-106	4
L	M-10671	4	250	B-106	4
Q	M-10672	4	150	B-106	4

- For sizes not listed, contact thermOweld®.
- For heavy duty connections, contact thermOweld®.
- For molds with wear plates, see page 135.
- For expedited service, contact thermOweld®.
- To order weld metal for use with EZ Lite Remote® insert TW before and EZ after weld metal number.
- Required Tools;
  - Handle Clamps w/ Flint Ignitor (see chart for correct handles)
  - † ~ Sold complete with frame
  - 38-0309-00 ~ Flint Ignitor or 38-EZLT-RU EZ Lite Remote®
- Other recommended accessories;
  - 40-0319-01 ~ Mold Cleaner for cartridge sizes #15-#65 (Price Key 3 Molds Only)
  - 38-3922-00 ~ Mold Cleaning Brush
  - 38-0135-00 ~ Cable Cleaning Brush
  - 38-0101-00 ~ Rasp
  - 38-4129-00 ~ Packing Material for cable code "C" & Larger Molds (CS-8 Molds Only)

Section 4 - Molds  
Lightning Protection Conductors

## CS-3

## TYPE MOLDS

*Angular Cable Drop to Vertical Steel Surface  
For Lightning Protection Conductors*

MOLDS FOR LIGHTNING PROTECTION CONDUCTORS					
Cable Code	Mold #	Price Key	Weld Metal	Handle Clamps	Lead Time
A	M-5145	4	65	B-106	2
B	M-5150	4	65	B-106	2
C	M-5149	4	90	B-106	2
D	M-5146	4	115	B-106	2
E	M-5147	4	115	B-106	2
F	M-5148	4	115	B-106	2
G	M-2440	4	150	B-106	2
H	M-2441	4	150	B-106	4
J	M-2442	4	150	B-106	4
K	M-2443	4	150	B-106	2
L	M-2444	4	200	B-106	4
Q	M-5138	4	115	B-106	2

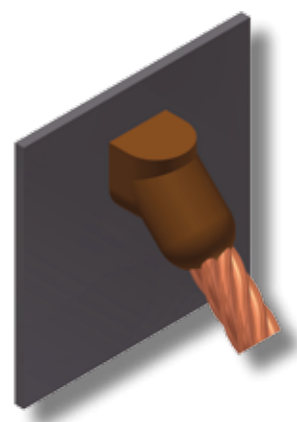

- **For sizes not listed, contact thermOweld®.**
- For heavy duty connections, contact thermOweld®.
- For molds with wear plates, see page 135.
- For expedited service, contact thermOweld®.
- To order weld metal for use with EZ Lite Remote® insert TW before and EZ after weld metal number.
- Required Tools;
  - Handle Clamps w/ Flint Ignitor (see chart for correct handles)
  - 38-0309-00 ~ Flint Ignitor or 38-EZLT-RU EZ Lite Remote®
- Other recommended accessories;
  - 40-0319-01 ~ Mold Cleaner for Cart. Size #15-#65 (PK-3 Molds Only)
  - 40-4431-00 ~ Magnetic Handle Clamp w/ B-106 Handles
  - 38-3922-00 ~ Mold Cleaning Brush
  - 38-0135-00 ~ Cable Cleaning Brush
  - 38-0101-00 ~ Rasp
  - 38-4129-00 ~ Packing Material for cable code "C" & Larger Molds (CS-9 Molds Only)

## CS-18

### TYPE MOLDS

**Horizontal Tap Cable to Vertical Steel Surface  
For Lightning Protection Conductors**

Note that the cable is ON the surface

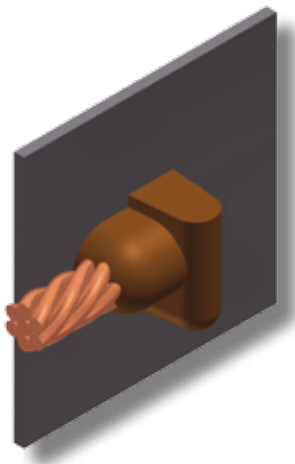

#### MOLDS FOR LIGHTNING PROTECTION CONDUCTORS

Cable Code	Mold # †	Price Key	Weld Metal	Handle Clamps	Lead Time
A	M-5054	4	45	B-106	4
B	M-10673	4	65	B-106	4
C	M-5205	4	65	B-106	2
D	M-5202	4	90	B-106	2
E	M-5203	4	115	B-106	4
F	M-5000	4	115	B-106	2
Q	M-11926	4	115	B-106	2

† Add (RH) to mold number for right hand mold or (LH) for left hand mold. Right hand (RH) mold will be furnished if none specified. EXAMPLE: M-5054-LH



Left Hand  
Mold



Right Hand  
Mold

- For sizes not listed, contact thermOweld®.
- For heavy duty connections, contact thermOweld®.
- For expedited service, contact thermOweld®
- To order weld metal for use with EZ Lite Remote® insert TW before and EZ after weld metal number.
- Required Tools;
  - Handle Clamps w/ Flint Ignitor (see chart for correct handles)
  - 38-0309-00 ~ Flint Ignitor or 38-EZLT-RU EZ Lite Remote®
- Other recommended accessories;
  - 40-0319-03 ~ Mold Cleaner for cartridge sizes #90-#500 (CS-6 Molds Only)
  - 40-4431-00 ~ Magnetic Handle Clamp w/ B-106 Handles
  - 38-3922-00 ~ Mold Cleaning Brush
  - 38-0135-00 ~ Cable Cleaning Brush
  - 38-0101-00 ~ Rasp
  - 38-4129-00 ~ Packing Material for cable code "C" & Larger Molds (CS-18 Molds Only)

# CS-6

## TYPE MOLDS

### Horizontal Thru Cable to Vertical Steel Surface For Lightning Protection Conductors

Note that the cable is OFF the surface

MOLDS FOR LIGHTNING PROTECTION CONDUCTORS					
Cable Code	Mold #	Price Key	Weld Metal	Handle Clamps	Lead Time
A	M-5171	4	90	B-106	4
B	M-5176	4	90	B-106	4
C	M-5175	4	115	B-106	2
D	M-5172	4	150	B-106	2
E	M-5173	4	150	B-106	4
F	M-5174	4	150	B-106	2
G	M-2461	4	150	B-106	4
H	M-2462	4	150	B-106	4
J	M-2463	4	200	B-106	4
K	M-2464	4	200	B-106	4
L	M-2465	4	250	B-106	4
Q	M-5179	4	150	B-106	2

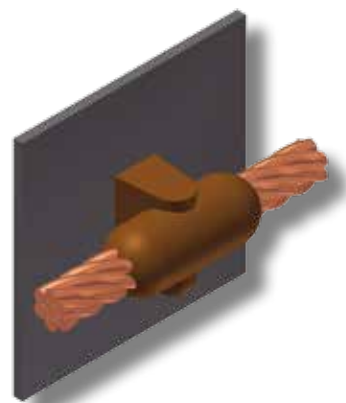

- For sizes not listed, contact thermOweld®.
- For heavy duty connections, contact thermOweld®.
- For expedited service, contact thermOweld®.
- To order weld metal for use with EZ Lite Remote® insert TW before and EZ after weld metal number.
- Required Tools;
  - Handle Clamps w/ Flint Ignitor (see chart for correct handles) 38-0309-00 ~ Flint Ignitor or 38-EZLT-RU EZ Lite Remote®
- Other recommended accessories;
  - 40-0319-03 ~ Mold Cleaner for cartridge sizes #90-#500 (CS-6 Molds Only)
  - 40-4431-00 ~ Magnetic Handle Clamp w/ B-106 Handles
  - 38-3922-00 ~ Mold Cleaning Brush
  - 38-0135-00 ~ Cable Cleaning Brush
  - 38-0101-00 ~ Rasp
  - 38-4129-00 ~ Packing Material for cable code "C" & Larger Molds (CS-18 Molds Only)

# CS-27

## TYPE MOLDS

### Horizontal Thru Cable to Vertical Steel Surface For Lightning Protection Conductors

Note that the cable is ON the surface

MOLDS FOR LIGHTNING PROTECTION CONDUCTORS					
Cable Code	Mold #	Price Key	Weld Metal	Handle Clamps	Lead Time
A	M-5162	4	65	B-106	4
B	M-5169	4	90	B-106	4
C	M-5168	4	115	B-106	2
D	M-5163	4	150	B-106	2
E	M-5165	4	150	B-106	4
F	M-5167	4	150	B-106	2
G	M-2856	4	150	B-106	4
H	M-2451	4	150	B-106	4
J	M-2452	4	200	B-106	4
K	M-2453	4	200	B-106	4
L	M-2454	4	250	B-106	4
Q	M-5152	4	150	B-106	2

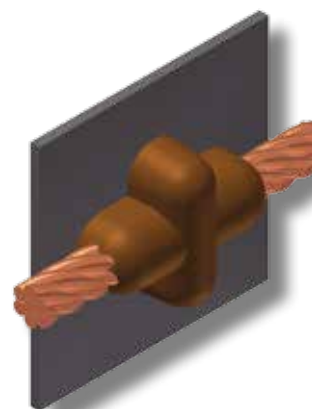

Section 4 - Molds  
Lightning Protection Conductors

## CS-4

### TYPE MOLDS

**Vertical Thru Cable to Vertical Steel Surface  
For Lightning Protection Conductors**

Note that the cable is OFF the surface

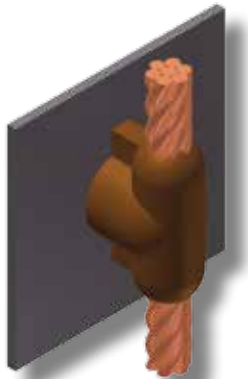

MOLDS FOR LIGHTNING PROTECTION CONDUCTORS					
Cable Code	Mold #	Price Key	Weld Metal	Handle Clamps	Lead Time
A	M-5153	4	90	B-106	4
B	M-5160	4	115	B-106	4
C	M-5159	17	200	B-106	2
D	M-5154	17	250	B-106	2
E	M-5156	17	2-150	B-106	2
F	M-5158	17	2-150	B-106	2
G	M-2445	17	2-150	B-106	4
H	M-2446	17	2-150	B-106	4
J	M-2447	6	2-200	B-106	4
K	M-2448	6	2-200	B-106	2
L	M-2449	6	500	B-106	4
Q	M-5144	17	250	B-106	2

## CS-7

### TYPE MOLDS

**Overhead Vertical Tap Cable to Vertical Steel Surface  
For Lightning Protection Conductors**

Note that the cable is ON the surface



MOLDS FOR LIGHTNING PROTECTION CONDUCTORS					
Cable Code	Mold #	Price Key	Weld Metal	Handle Clamps	Lead Time
A	M-5180	4	90	B-106	4
B	M-5200	4	90	B-106	4
C	M-5185	4	115	B-106	2
D	M-5181	17	150	B-106	2
E	M-5182	17	150	B-106	4
F	M-5184	17	150	B-106	2
G	M-2466	17	150	B-106	4
H	M-2467	17	150	B-106	4
J	M-2468	17	200	B-106	4
K	M-2469	17	200	B-106	4
L	M-2470	17	250	B-106	4
Q	M-5161	17	150	B-106	2

- For sizes not listed, contact thermOweld®.
- For heavy duty connections, contact thermOweld®.
- For molds with wear plates, see page 135.
- For expedited service, contact thermOweld®.
- To order weld metal for use with EZ Lite Remote® insert TW before and EZ after weld metal number.
- Required Tools;
  - Handle Clamps w/ Flint Ignitor (see chart for correct handles)
  - 38-0309-00 ~ Flint Ignitor or 38-EZLT-RU EZ Lite Remote®
- Other recommended accessories;
  - 40-4431-00 ~ Magnetic Handle Clamp w/ B-106 Handles
  - 38-3922-00 ~ Mold Cleaning Brush
  - 38-0135-00 ~ Cable Cleaning Brush
  - 38-0101-00 ~ Rasp



## CB-1

## TYPE MOLDS

**Horizontal Cable Tap to Horizontal Lug or Bus  
For Lightning Protection Conductors**

See pages 159-160 for Lug part numbers.

MOLDS FOR LIGHTNING PROTECTION CONDUCTORS						
Cable Size	Lug Size	Mold #	Price Key	Weld Metal	Handle Clamps	Lead Time
A	1/8" X 1"	M-2471	4	65	B-106	2
B		M-2472	4	65	B-106	4
C		M-2473	4	90	B-106	2
D		M-2474	4	90	B-106	2
E		M-2475	4	90	B-106	2
F		M-2521	4	90	B-106	4
G		M-5008	4	90	B-106	2
H		M-5009	4	90	B-106	4
J	3/16" X 1"	M-2201	4	115	B-106	4
K		M-5030	4	115	B-106	2
Q		M-11928	4	90	B-106	2
J	1/4" X 1"	M-5029	4	115	B-106	4
K		M-5031	4	150	B-106	2
L		M-5034	4	150	B-106	4
Q		M-11927	4	90	B-106	2

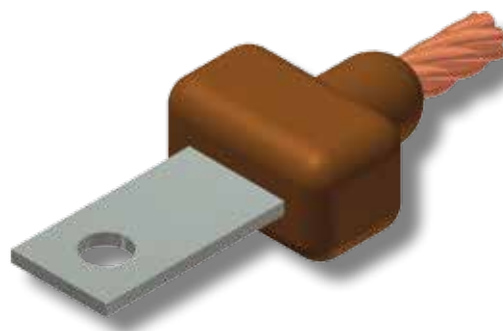

- **For sizes not listed, contact thermOweld®.**
- For heavy duty connections, contact thermOweld®.
- For molds with wear plates, see page 135.
- For expedited service, contact thermOweld®.
- To order weld metal for use with EZ Lite Remote® insert TW before and EZ after weld metal number.
- Required Tools;
  - Handle Clamps w/ Flint Ignitor (see chart for correct handles)  
38-0309-00 ~ Flint Ignitor or 38-EZLT-RU EZ Lite Remote®
- Other recommended accessories;
  - 38-3922-00 ~ Mold Cleaning Brush
  - 38-0135-00 ~ Cable Cleaning Brush

## AC-1 / AC-2

### TYPE MOLDS

#### Horizontal Cable to Aircraft Grounding Receptacle

Types AC-1 and AC-2 are made with the receptacle in an inverted position. The resulting riser is then used to position the receptacle on top of 1/2" IPS pipe. See page 126 for Aircraft Grounding Receptacle part numbers.

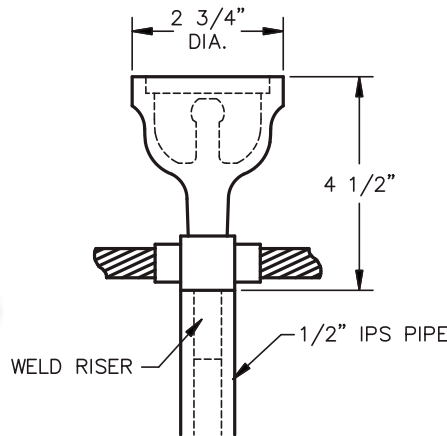

AC-1

AC-2

### MOLDS FOR LIGHTNING PROTECTION CONDUCTORS

AC-1					CABLE CODE	AC-2				
MOLD #	PRICE KEY	WELD METAL	HANDLE CLAMPS	LEAD TIME		MOLD #	PRICE KEY	WELD METAL	HANDLE CLAMPS	LEAD TIME
M-10674	4	115	B-106	4	A	M-10686	4	115	B-106	4
M-10675	4	115	B-106	4	B	M-10687	4	115	B-106	4
M-10676	4	150	B-106	4	C	M-10688	4	150	B-106	4
M-10677	4	150	B-106	4	D	M-10689	4	200	B-106	4
M-10678	4	150	B-106	4	E	M-10690	4	200	B-106	4
M-10679	4	150	B-106	4	F	M-10691	4	200	B-106	4
M-10680	4	150	B-106	4	G	M-10692	4	200	B-106	4
M-10681	4	150	B-106	4	H	M-10693	4	200	B-106	4
M-10682	4	200	B-106	4	J	M-10694	4	250	B-106	4
M-10683	4	250	B-106	4	K	M-10695	4	2-150	B-106	4
M-10684	4	250	B-106	4	L	M-10696	4	2-150	B-106	4
M-10685	4	150	B-106	4	Q	M-10697	4	200	B-106	4

- For sizes not listed, contact thermOweld®.
- For heavy duty connections, contact thermOweld®.
- For molds with wear plates, see page 135.
- For expedited service, contact thermOweld®.
- To order weld metal for use with EZ Lite Remote® insert TW before and EZ after weld metal number.
- Required Tools;
  - Handle Clamps w/ Flint Ignitor (see chart for correct handles)
  - 38-0309-00 ~ Flint Ignitor or 38-EZLT-RU EZ Lite Remote®
- Other recommended accessories;
  - 38-3922-00 ~ Mold Cleaning Brush
  - 38-0135-00 ~ Cable Cleaning Brush

Section 4 - Molds  
Lightning Protection Conductors